

成为呵护全民口腔健康，全身健康的核心力量

**Best Quality Best Brand**

**UMG**

唐山市佑美医疗器械有限公司  
Tangshan UMG Medical Instrument Co.,Ltd

唐山市佑美医疗器械有限公司  
**Tangshan UMG Medical Instrument Co.,Ltd**  
唐山市高新区唐山师范学院国际交流中心C座328室  
Room 328,Block C,International Exchange,High-tech District,  
Tangshan,China.  
**Tel-0315-6314398**  
Email:info@umgroupen.com  
[Http://www.umgroupen.com](http://www.umgroupen.com)

# Rotary Super Gold Files

## 金色变锥锉



**Especial golden files**  
百炼成金

**Strong &Flexible**  
超强抗折断

**Special processing technique**  
精湛的处理工艺

**More sharp**  
更锐利

# Rotary Super Gold Files

## 金色变锥锉

### Varitaper (Gold heat activation)

- Made of high quality niti alloy , after heat activation treatment becomes golden color
- Good flexibility, high quality cutting efficiency and fracture resistance,
- Recommended rotary speed of engine files is 150-350 r/min
- 6pcs per pack, available for single or assorted sizes.
- Torque.2.0n.cm~3.0n.cm

### 镍钛机用变锥锉 (金色热激活)

- 材料为高质量的镍钛合金，经过热处理后变成金色
- 刃部为多锥度设计，使锉的弹性和切削力更好
- 推荐转速为150-300转/分钟
- 6支装：可分单色装和混色装
- 扭矩：2.0N.cm-3.0N.cm

Size	21mm	25mm	31mm
SX	EGV+0190SX	EGV+0190SX	EGV+0190SX
S1	EGV+0210S1	EGV+0250S1	EGV+0310S1
S2	EGV+0210S2	EGV+0250S2	EGV+0310S2
F1	EGV+0210F1	EGV+0250F1	EGV+0310F1
F2	EGV+0210F2	EGV+0250F2	EGV+0310F2
F3	EGV+0210F3	EGV+0250F3	EGV+0310F3
SX-F3	EGV+021203	EGV+025203	EGV+031203
		EGV+025204	EGV+031204

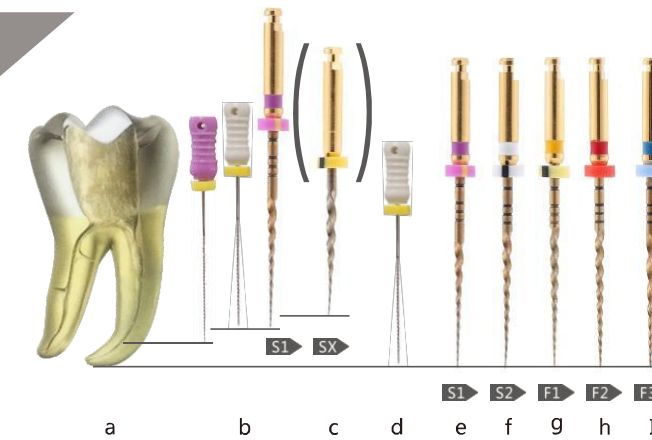

### 操作步骤

- First establish a glide path
  - Probe the canal by using K file , No.10# , 15#
  - Use Sx enlarge the canal continued by S1
  - use 15#hand file to probe the working length
  - use S1 file to working length
  - use S2 file to working length
  - use F1 file to working length
  - use F2 file to working length
  - use F3 file to working length (alternative when it need )
- 建立直线通道
  - 用10# , 15#K锉探查根管
  - 扩大冠部 (使用S1) 必要时接着使用SX (进入深度不大于15#K锉深度)
  - 测量/确定工作长度 (使用15#K锉)
  - 使用S1预备到工作长度
  - 使用S2预备到工作长度
  - 使用F1预备到工作长度
  - 使用F2预备到工作长度 (被推荐是最小的) 根尖预备器械, 然后进行根部狭窄处直线的测量
  - 使用F3预备到工作长度 (用于大的根管)

# Rotary Super Blue Files

## 蓝色热激活变锥锉

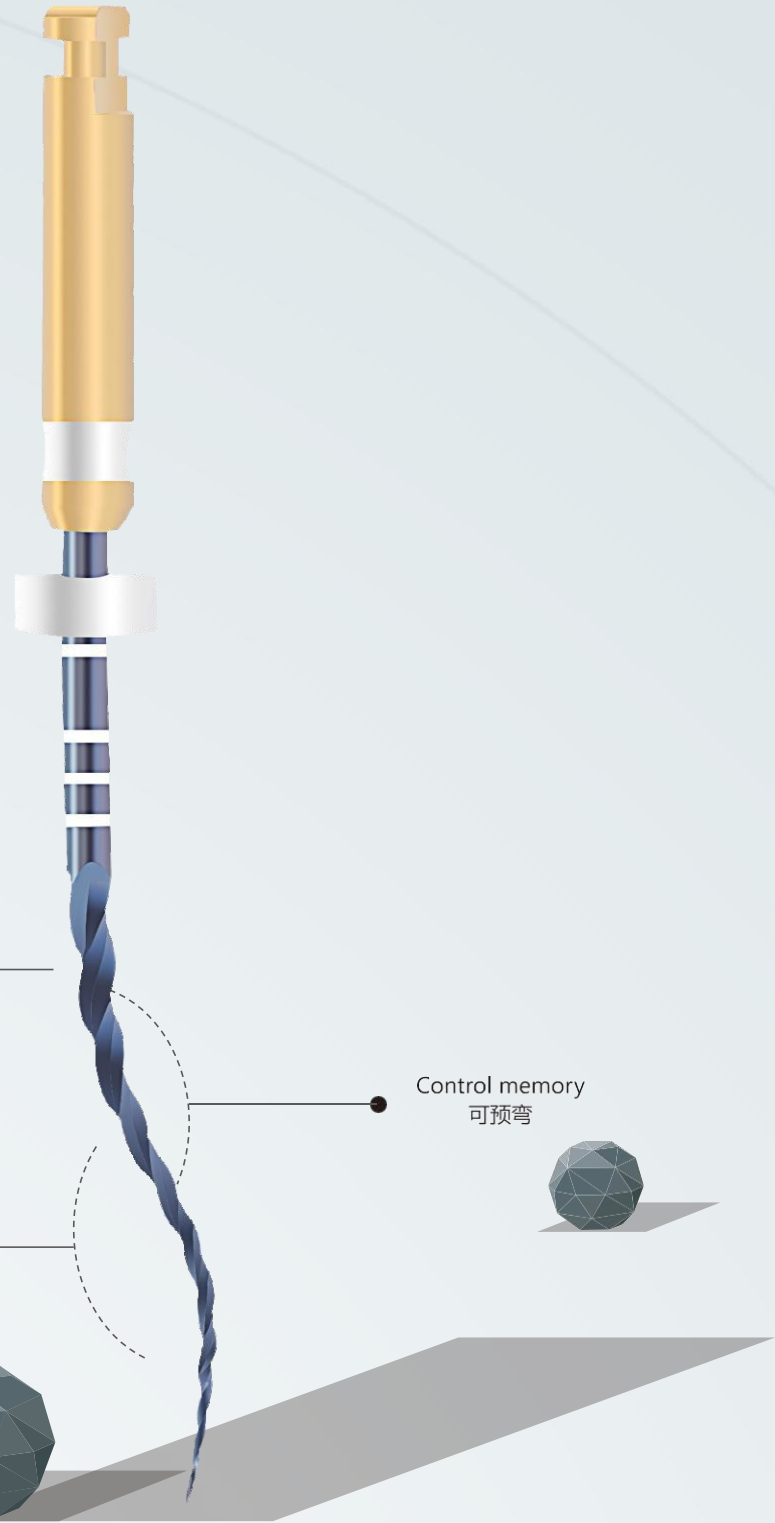

Triangle cross  
凸三角形截面

Control memory  
可预弯

Heat activation CM-wire  
超强韧性

- Cm-wire heat treatment technology, safety
- Security guide tip, reduce the possibility of root canal deviation
- Smart varied taper design efficiency

**CM-wire热处理技术**  
全新的热激活镍钛材质，强韧安全

**安全的引导锥尖**  
更容易顺着根管的原始形态深入预备，将根管偏移的可能性降到最低，避免侧穿

**睿智的变锥设计**  
在有效的根管扩大过程中，最大程度的保留牙本质和根管原始形态

# Rotary Super Blue Files

## 蓝色热激活变锥锉

### Varitaper ( NITI heat activation )

- Made of high quality controled menmemory wire , after heat activation treatment becomes blue color
- Blue files flexible and tough, can be pre-curved suitable for bending curved root canal
- More sharp amd better performance for canal preparation
- 6pcs per pack, available for single or assorted sizes.

### 镍钛机用变锥锉 ( 蓝色热激活 )

- 材料为高质量的镍钛合金，经过热激活处理后变成蓝色
- 蓝色锉针，柔软强韧，可预弯，适合处理弯曲根管
- 更锋利更适用于根管预备
- 6支装：可分单色装和混色装

	型号 Model	SX	S1	S2	F1	F2	F3
	锥度 Taper	3.5-19	02-11	04-11.5	07	08	09
	尖端直径 Diameter	#19	#17	#20	#20	#25	#30
	长度 Length	19mm	21/25mm				
	扭矩 Torque	3.0N.cm	3.0N.cm	1.0N.cm	1.60N.cm	2.0N.cm	2.0N.cm
	转速 Speed	250~350prm					

Size	21mm	25mm	31mm
SX	EBV+0190SX	EBV+0190SX	EBV+0190SX
S1	EBV+0210S1	EBV+0250S1	EBV+0310S1
S2	EBV+0210S2	EBV+0250S2	EBV+0310S2
F1	EBV+0210F1	EBV+0250F1	EBV+0310F1
F2	EBV+0210F2	EBV+0250F2	EBV+0310F2
F3	EBV+0210F3	EBV+0250F3	EBV+0310F3
SX-F3	EBV+021203	EBV+025203	EBV+031203
		EBV+025204	EBV+031204

Operation process 操作步骤	
Probe File 探查	#10
	#15
Shapping files 根管部	S1
	S2
Opening files 根管口扩大	SX
Finishing files 根尖部	F1
	F2
	F3

# Rotary V+ Blue Files

## 机用镍钛热激活V+ 往返单只锉

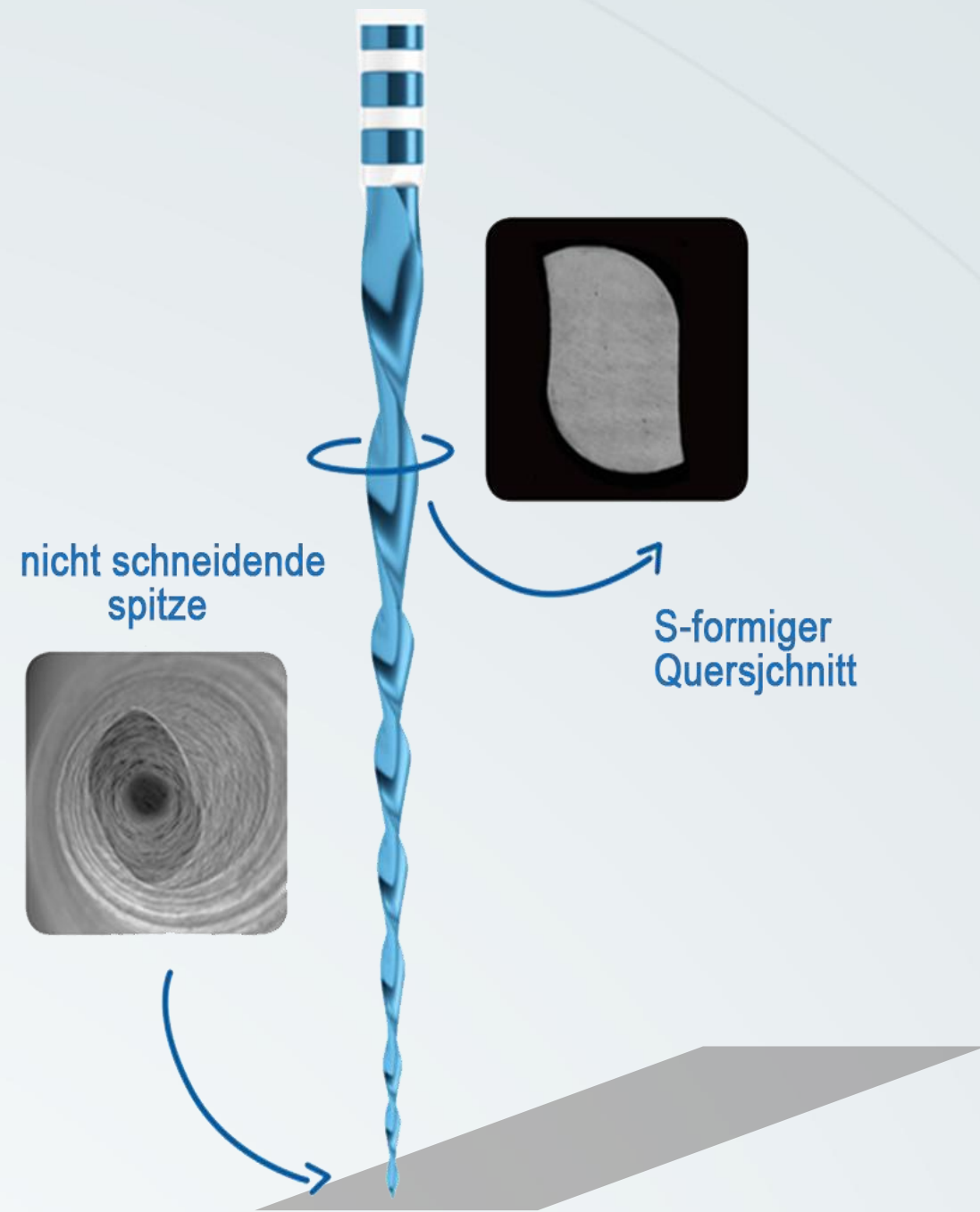

# Rotary V+ Blue Files

## 机用镍钛热活V+ 往返单只锉

### Rotary V+Blue Files

- The files body adopts unique mirrored S-shaped cross section
- RECIPROC®Blue is packed sterile and independent
- Open for instant use, provide continuous and efficient cutting, and prevent cross infection
- Ensures efficient preparation and filling for extremely curved root canal
- Easily choose the right instrument
- Single files for root canal preparation
- Greatly reduce the preparation time
- mm nickel-plated short handle for more flexibility in the posterior

### 机用镍钛热活V+往返单只锉

- 锉体使用独特的S镜面
- RECIPROC®单支锉, 无菌独立包装, 即拆即用, 能提供连续高效切割, 并且有效防止交叉感染
- 对于极度弯曲根管也能确保高效预备和充填
- 轻松选择合适的器械
- 单支锉进行根管预备
- 极大地减少预备时间
- 毫米镀镍短手柄, 在后牙区使用更为灵活

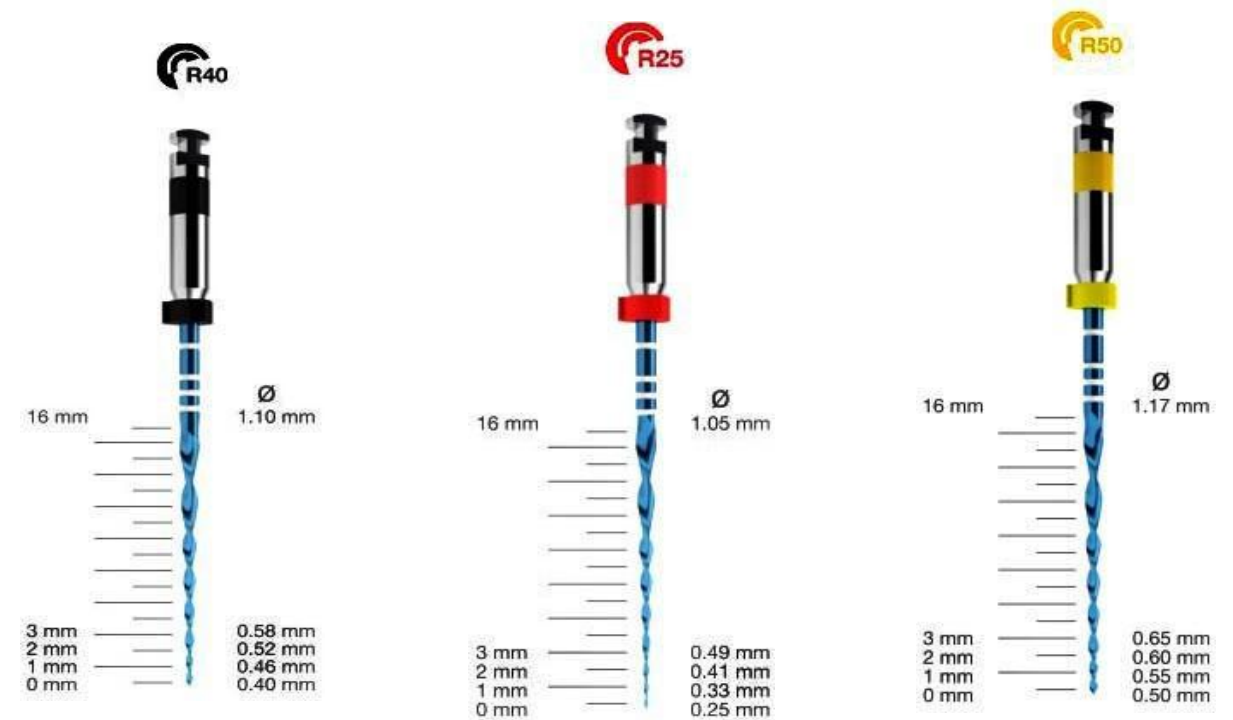



# Rotary W<sup>+</sup> Gold Files

## 机用镍钛 W<sup>+</sup> Gold单只锉



- Optimized tip
- Variable taper
- GOLD thermal treatment
- Evolving cross-section
- Reciprocating motion

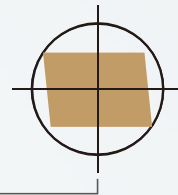

# Rotary W<sup>+</sup> Gold Files

## 机用镍钛 W<sup>+</sup> Gold单只锉

### Rotary W<sup>+</sup>Gold Files

Engineered with the latest reciprocating technology

- Increases patient safety, while reducing shaping time across a wide range of cases
- Optimized with enhanced design features by leading endodontists
- Part of a complete solution that includes obturation products designed to match the shapes created by W<sup>+</sup> Gold files
- The W<sup>+</sup> Gold family now includes a single glide path file with reciprocating motion for simplicity from the start
- Respects the natural shape of the canal
- Increases patient safety with enhanced flexibility and resistance to cyclic fatigue
- Sterile and ready for single use, which preserves cutting efficiency, reduces breakage and prevents cross contamination

### 机用镍钛 W<sup>+</sup>Gold 单只锉

采用最新的往复技术设计

- 缩短各种情况下的塑形时间的同时，提高患者安全
- 由领先的牙髓病医生进行设计优化
- 完整解决方案的一部分包括设计封闭产品旨在匹配 W<sup>+</sup>Gold根管锉的形状
- W<sup>+</sup> Gold系列现在包含一个滑动根管锉从开始就简化往复运动
- 遵循根管的原始形态
- 通过增强灵活性和抗周期性疲劳来提高患者安全性
- 无菌，可随时使用，保持切割效率，减少破损并防止交叉污染



# Rotary V-Files

## 往返挫

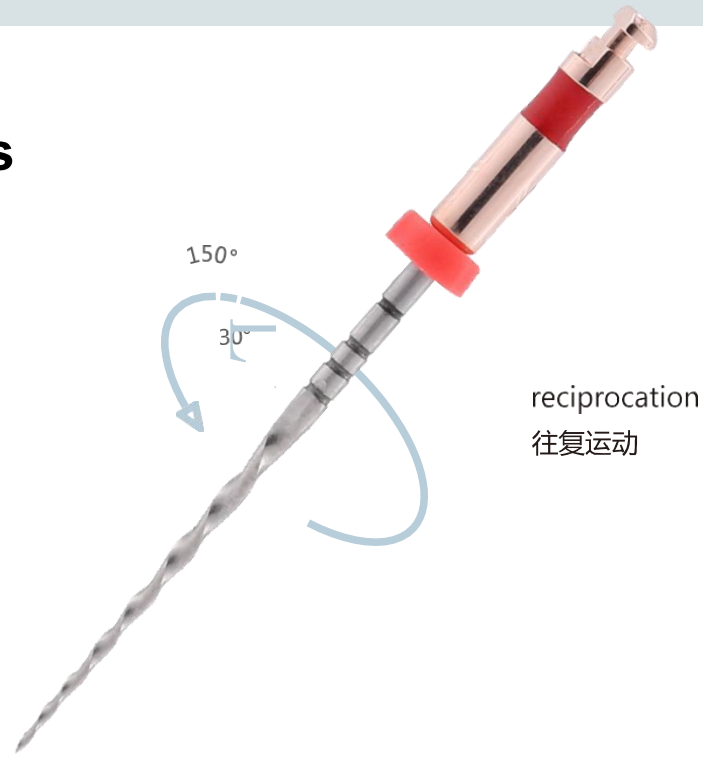

往返挫

- One instrument only can prepare a root canal
- Effective with less steps, time saving
- Special screw thread, reciprocating motion
- 4 sizes can be choose for different root canals
- This product has gold and blue hot activation ,better performance
- 6pcs per pack, available for single or assorted sizes.
- 单支器械就能完成根管预备
- 工作步骤少, 高效省时
- 特殊的螺纹设计, 往复运动
- 四种尺寸可供选择, 适合不同形态根管
- 本品有黄金装和蓝色热激活装, 性能更加优良
- 6支装. 可分单色装和混色装

Time-saving

省时

- Efficiency
- 高效
- One file can finish root canal therapy
- 一支挫可完成根管预备

Size	21mm	25mm	31mm
R20	ENE+021020	ENE+025020	ENE+031020
R25	ENE+021025	ENE+025025	ENE+031025
R40	ENE+021040	ENE+025040	ENE+031040
R50	ENE+021050	ENE+025050	ENE+031050
R20-50	ENE+021203	ENE+025203	ENE+031203



Especial screw  
特殊的螺纹设计

# Rotary Supper Files

## 变锥挫

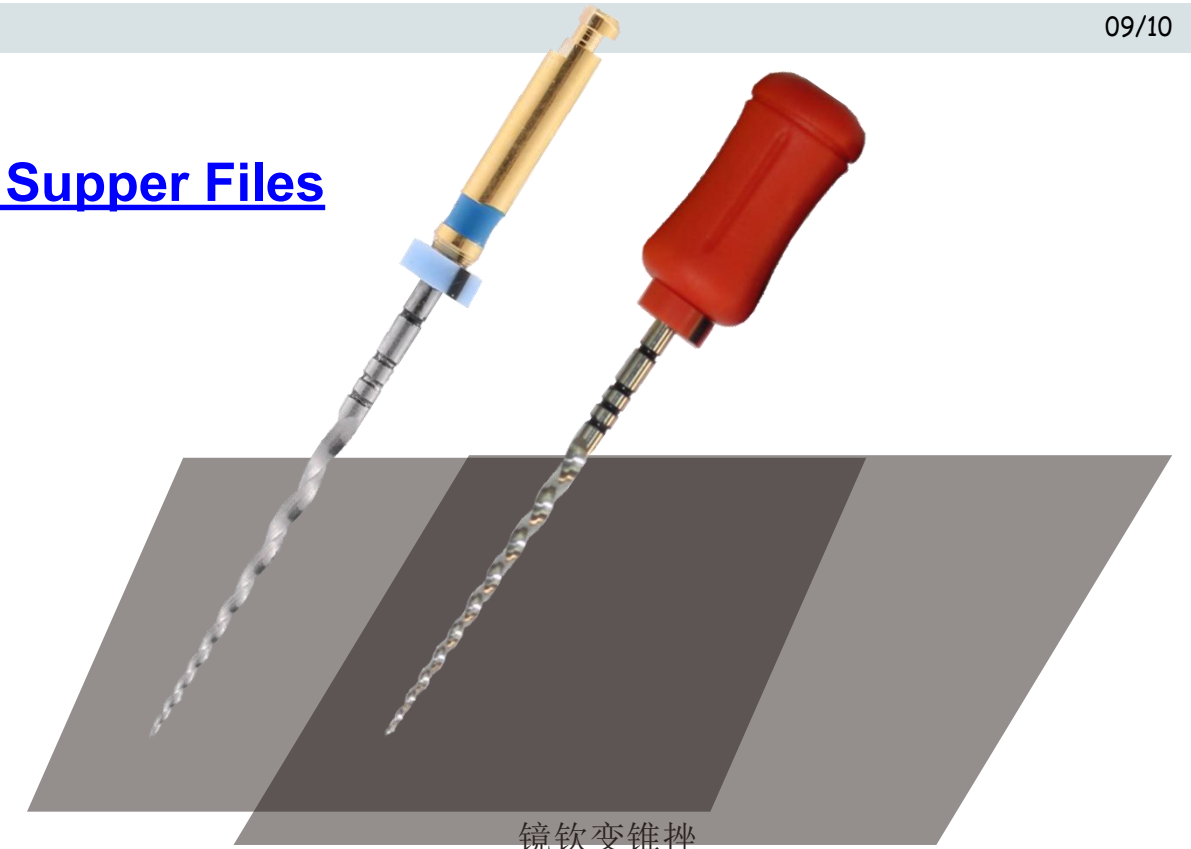

镜钦变锥挫

沪 FILES

- Made of high quality nitalloy,
- Good flexibility, high quality cutting efficiency and fracture resistance,
- Recommended rotary speed of engine files is 150-350 r/min
- 6pcs per pack, available for single or assorted sizes .
- Torque : 2.5Ncm

- 材料为高质量的镶钦合金
- 刃部为多锥度设计, 使挫的弹性和切削力更好
- 推荐转速为150-300 转 / 分钟
- 6支装: 可分单色和混色装扭
- 矩2.5N.cm

Operation instrution

模式调节

Step 模式	Speed 转速	Torque 扭矩	Target Files 对应镶钦挫
Ste p1 模式一	250r/ min	3.0N.cm	Sx, S1
Ste p2 模式二	250r/ min	LON.cm	S2
Ste p3 模式三	250r/ min	1.6N.cm	F1
Ste p4 模式四	250r/ min	2.0N.cm	F2, F3

Size	21mm	25mm	31mm
○ sx	ENV+0190SX	ENV+0190SX	ENV+0190SX
• 51	ENV+0210S1	ENV+0250S1	ENV+0310S1
○ S2	ENV+0210S2	ENV+0250S2	ENV+0310S2
○ F1	ENV+0210F1	ENV+0250F1	ENV+0310F1
• F2	ENV+0210F2	ENV+0250F2	ENV+0310F2
• F3	ENV+0210F3	ENV+0250F3	ENV+0310F3
• F4	ENV+0210F4	ENV+0250F4	ENV+0310F4
○ F5	ENV+0250F5	ENV+0250F5	ENV+0310F5
SX-F3	ENV+021203	ENV+025203	ENV+031203
S1-F1	ENV+021204	ENV+025204	ENV+031204

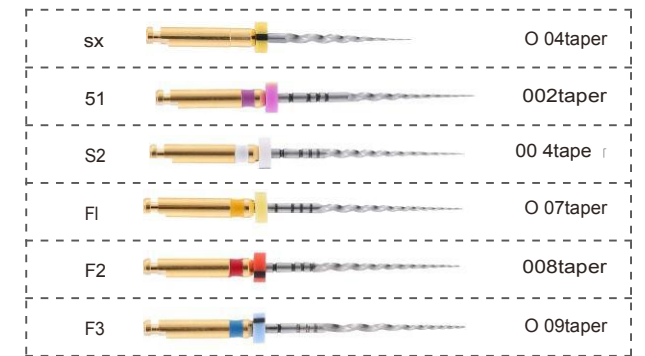

# J3-FILES



# J3-FILES

## J3-FILES

- Made of high quality niti alloy with a flexible performance after special process
- Improved the fracture resistance
- Forward cutting angle with excellent cutting efficiency ,easy to discharge debris
- Secure round pointed end that could avoid the steps or side perforation
- Adaptive thread makes the files efficient ,flexible and high strength
- Recommended rotary speed 250-350 round/min, Torque 2.5N.cm
- 6pcs per pack, available for single or assorted sizes (2 hand K files, 4 engine files)

## J3令坐

- 材料 为高质量的银钨合金, 经过特殊工艺处理后 , 具有柔顺的性能, 提高了抗断性。
- 正向切割角, 切割效果佳, 易干碎屑排出
- 安全圆形尖端, 避免台阶和侧穿
- 适应性螺纹, 使器械高效, 柔韧且强度高
- 推荐转速250-350 转 / 分钟, 扭矩2.5N .cm
- 6支装 . 可分单色装和混色装 ( 2支手用K挫, 4支机用挫 )

Size	21mm	25mm	31mm
R	ENJ301700R	ENJ301700R	ENJ301700R
S1	ENJ30210S1	ENJ30250S1	ENJ30310S1
S2	ENJ30210S2	ENJ30250S2	ENJ30310S2
S3	ENJ30210S3	ENJ30250S3	ENJ30310S3
R-S3	ENJ3021203	ENJ3025203	ENJ3031203

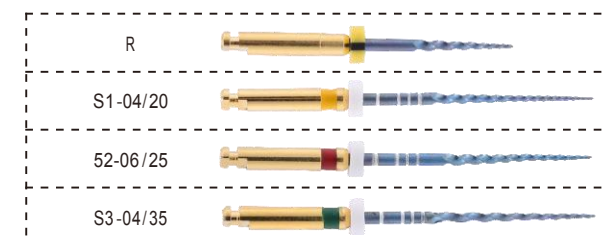

Use size "R" to open root canal, build glide path

- 用觅且号 (开口挫) 敞开根管上段, 建立进入根管的直线通道  
Speed 转速: 350RPM  
Torque 扭力 2.5N.cm
- Use S1,S2, S3 step by step enlarge root canal  
按顺序使用S1, 52, S3扩大根管  
Speed 转 速 250~300RPM
- Torque 扭 力 2.5N.cm

## Operation process 操作步骤

Probe File 探查	#10 #15	
Opening files 根管口扩大	∞	
Shapping& finishing files 根尖部	S1 -04/20	
	52 -06/ 25	
	S3 -04/35	

# Root Canal Files(Hand use)

**TYPE** CROSS SECTION

## K-Files

Stainless Steel/NITI

Length : 21mm 25mm 28mm 31mm



Size	21mm	25mm	28mm	31mm
06#	HSK0221006	HSK0225006	HSK0228006	HSK0231006
08#	HSK0221008	HSK0225008	HSK0228008	HSK0231008
10#	HSK0221010	HSK0225010	HSK0228010	HSK0231010
15#	HSK0221015	HSK0225015	HSK0228015	HSK0231015
20#	HSK0221020	HSK0225020	HSK0228020	HSK0231020
25#	HSK0221025	HSK0225025	HSK0228025	HSK0231025
30#	HSK0221030	HSK0225030	HSK0228030	HSK0231030
35#	HSK0221035	HSK0225035	HSK0228035	HSK0231035
40#	HSK0221040	HSK0225040	HSK0228040	HSK0231040
15-40#	HSK0221200	HSK0225200	HSK0228200	HSK0231200
45-80#	HSK0221201	HSK0225201	HSK0228201	HSK0231201
15-25#	HSK0221202	HSK0225202	HSK0228202	HSK0231202

## H-Files

Stainless Steel/NITI

Length : 21mm 25mm 28mm 31mm



Size	21mm	25mm	28mm	31mm
06#	HSH0221006	HSH0225006	HSH0228006	HSH0231006
08#	HSH0221008	HSH0225008	HSH0228008	HSH0231008
10#	HSH0221010	HSH0225010	HSH0228010	HSH0231010
15#	HSH0221015	HSH0225015	HSH0228015	HSH0231015
20#	HSH0221020	HSH0225020	HSH0228020	HSH0231020
25#	HSH0221025	HSH0225025	HSH0228025	HSH0231025
30#	HSH0221030	HSH0225030	HSH0228030	HSH0231030
35#	HSH0221035	HSH0225035	HSH0228035	HSH0231035
40#	HSH0221040	HSH0225040	HSH0228040	HSH0231040
15-40#	HSH0221200	HSH0225200	HSH0228200	HSH0231200
45-80#	HSH0221201	HSH0225201	HSH0228201	HSH0231201
15-25#	HSH0221202	HSH0225202	HSH0228202	HSH0231202

## Reamers

Stainless Steel/NITI

Length : 21mm 25mm 28mm 31mm



Size	21mm	25mm	28mm	31mm
06#	HSR0221006	HSR0225006	HSR0228006	HSR0231006
08#	HSR0221008	HSR0225008	HSR0228008	HSR0231008
10#	HSR0221010	HSR0225010	HSR0228010	HSR0231010
15#	HSR0221015	HSR0225015	HSR0228015	HSR0231015
20#	HSR0221020	HSR0225020	HSR0228020	HSR0231020
25#	HSR0221025	HSR0225025	HSR0228025	HSR0231025
30#	HSR0221030	HSR0225030	HSR0228030	HSR0231030
35#	HSR0221035	HSR0225035	HSR0228035	HSR0231035
40#	HSR0221040	HSR0225040	HSR0228040	HSR0231040
15-40#	HSR0221200	HSR0225200	HSR0228200	HSR0231200
45-80#	HSR0221201	HSR0225201	HSR0228201	HSR0231201
15-25#	HSR0221202	HSR0225202	HSR0228202	HSR0231202

**TYPE** CROSS SECTION

## Flexile files

Stainless Steel

Length : 21mm 25mm 28mm 31mm



Size	21mm	25mm	28mm	31mm
08#	HTF0221008	HTF0225008	HTF0228008	HTF0231008
10#	HTF0221010	HTF0225010	HTF0228010	HTF0231010
15#	HTF0221015	HTF0225015	HTF0228015	HTF0231015
20#	HTF0221020	HTF0225020	HTF0228020	HTF0231020
25#	HTF0221025	HTF0225025	HTF0228025	HTF0231025
30#	HTF0221030	HTF0225030	HTF0228030	HTF0231030
35#	HTF0221035	HTF0225035	HTF0228035	HTF0231035
40#	HTF0221040	HTF0225040	HTF0228040	HTF0231040
15-40#	HTF0221200	HTF0225200	HTF0228200	HTF0231200
45-80#	HTF0221201	HTF0225201	HTF0228201	HTF0231201

## Pluggers

Stainless Steel/NITI

Length : 21mm 25mm 28mm 31mm



Size	21mm	25mm	28mm	31mm
15#	HSS0221015	HSS0225015	HSS0228015	HSS0231015
20#	HSS0221020	HSS0225020	HSS0228020	HSS0231020
25#	HSS0221025	HSS0225025	HSS0228025	HSS0231025
30#	HSS0221030	HSS0225030	HSS0228030	HSS0231030
35#	HSS0221035	HSS0225035	HSS0228035	HSS0231035
40#	HSS0221040	HSS0225040	HSS0228040	HSS0231040
15-40#	HSS0221200	HSS0225200	HSS0228200	HSS0231200
45-80#	HSS0221201	HSS0225201	HSS0228201	HSS0231201

## Spreaders

Stainless Steel/NITI

Length : 21mm 25mm 28mm 31mm



Size	21mm	25mm	28mm	31mm
15#	HSP0221015	HSP0225015	HSP0228015	HSP0231015
20#	HSP0221020	HSP0225020	HSP0228020	HSP0231020
25#	HSP0221025	HSP0225025	HSP0228025	HSP0231025
30#	HSP0221030	HSP0225030	HSP0228030	HSP0231030
35#	HSP0221035	HSP0225035	HSP0228035	HSP0231035
40#	HSP0221040	HSP0225040	HSP0228040	HSP0231040
15-40#	HSP0221200	HSP0225200	HSP0228200	HSP0231200
45-80#	HSP0221201	HSP0225201	HSP0228201	HSP0231201



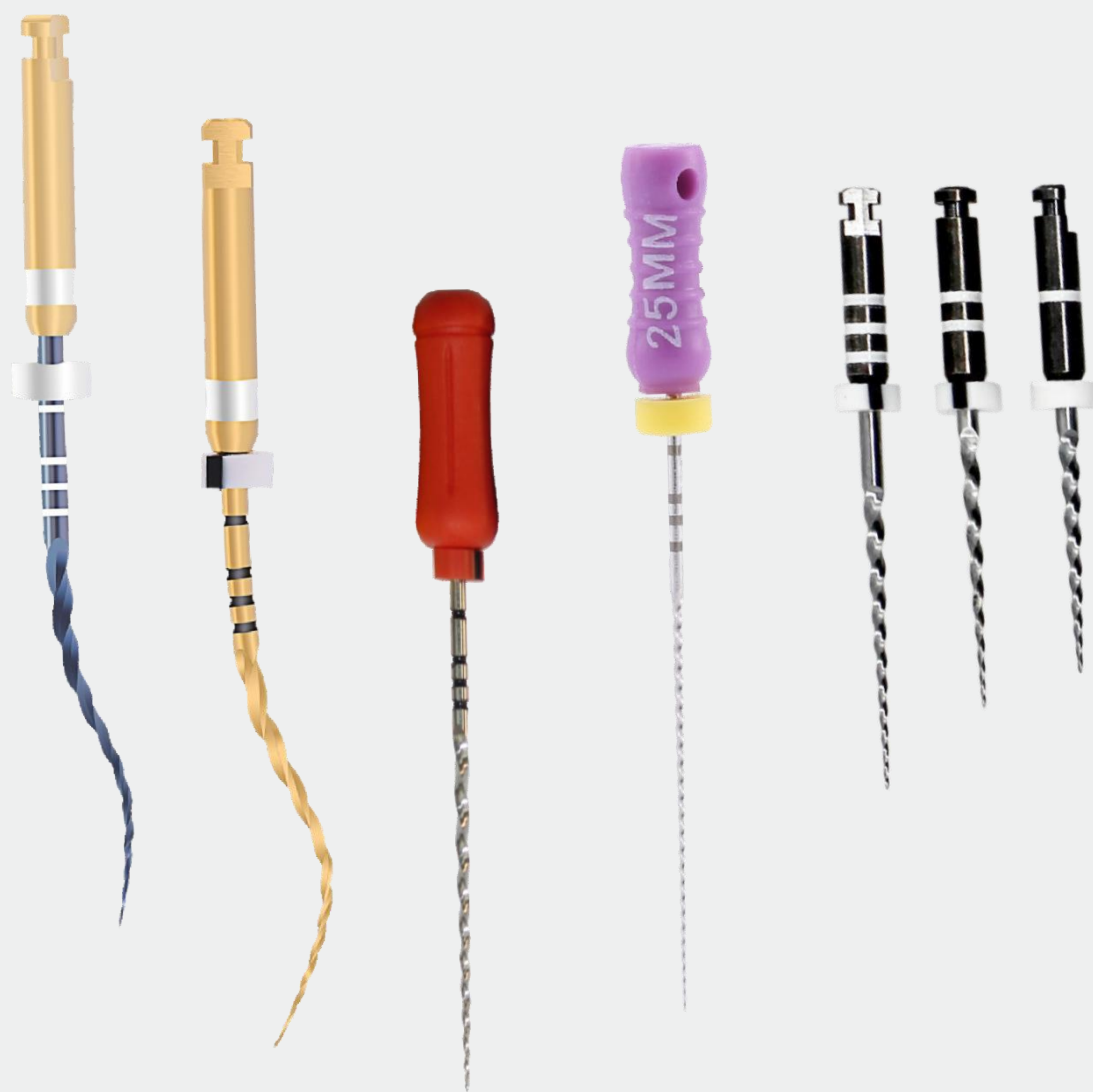

### PI-Files

- Made of niti alloy, square section
- 2% taper, use for building a smooth path
- Save time compared to manual stainless steel files.
- 6pcs per pack, available for single or assorted sizes.

### PI 挫

- 镍钛材质，正方形的横截面，
- 2%的锥度，用于疏通根管
- 和手动挫相比，可以大大减少操作时间。
- 6支装，分单色装和混色装。

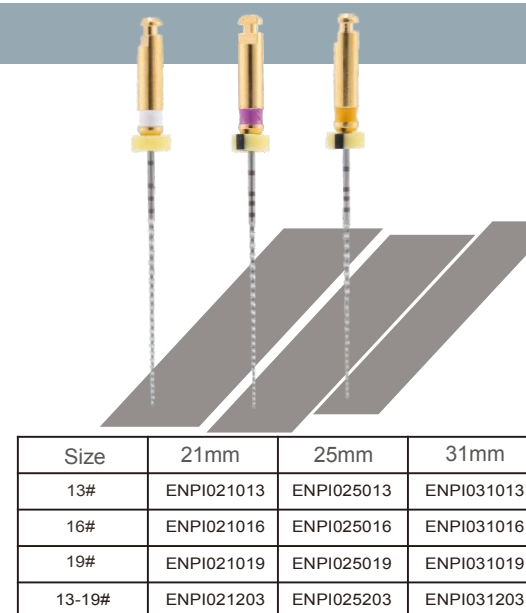

### S+-Files

- Made of high quality NiTi alloy.
- make it possible to shape more severely curved narrow canals.
- The high cutting efficiency also save the shaping time.
- Recommended rotary speed is 150~350r/Min. Torque 2.5N.cm

- 3pcs per pack, available for single or assorted sizes.

### 蛇形挫

- 材料为高质量的镍钛合金。
- 独特的运动和更大的灵活性，适用于更严重弯曲狭窄的根管。
- 高效的切割效率使根管成型时间大大减少。
- 推荐旋转速度为150~350 转 / 分钟，扭矩2.5N.cm
- 3支装，分单色装和混色装。

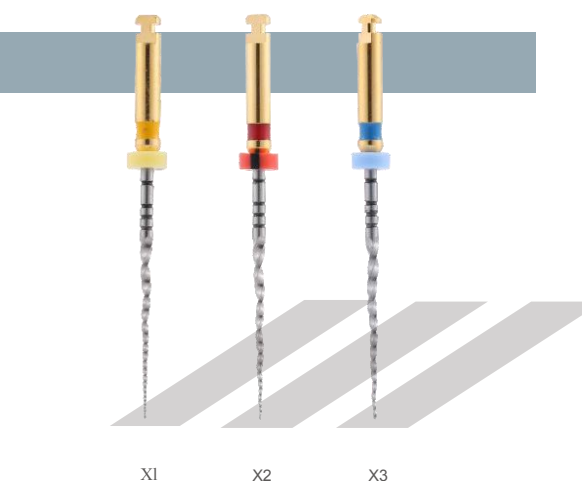

Size	21mm	25mm	31mm
X1	ENS+0210S1	ENS+0250S1	ENS+0310S1
X2	ENS+0210S2	ENS+0250S2	ENS+0310S2
X3	ENS+0210S3	ENS+0250S3	ENS+0310S3
X4	ENS+0210S4	ENS+0250S4	ENS+0310S4
X5	ENS+0210S5	ENS+0250S5	ENS+0310S5

### RS-FILES

- Made of high quality Special nickel alloy with good resistance and elasticity.
- Specific taper and cross section design to improve efficiency.
- Taper : 0.04 and 0.06
- Length: 21mm and 25mm and 29mm
- Recommended rotary speed is 280~300r/Min.Torque 2.SN.cm
- 6pcs per pack, available for single or assorted sizes.



Size	21mm	25mm	29mm
SC1	ENRS021SC1	ENRS025SC1	ENRS029SC1
SC2	ENRS021 SC2	ENRS025SC2	ENRS029SC2
SU	ENRS0210SU	ENRS0210SU	ENRS0210SU
SC1-SU	ENRS021203	ENRS025203	ENRS029203

### RS 锉

- 材料为专用镍钛合金，具有良好的抗折性和弹性。
- 特殊的锥度和截面设计，大大提高工作效率。
- 锥度种类：0.04和0.06;
- 工作长度：21mm ,25mm ,29mm .
- 推荐旋转速度为280~300 转 / 分钟，扭矩2.SN.cm
- 6支装：分单色装和混色装。

## RT-Files

- Special-purpose nickel-titanium alloy with good resistance and elasticity.
- Use for removing gutta percha and fillings in root canal.
- Recommended speed is 150~300r/Min.Torque 2.SN.cm
- 3pcs per pack, available for single or assorted sizes.



Size	16mm	18mm	22mm
01	ENRT0160D1		
D2		ENRT0180D2	
D3			ENRT0220D3
D1-D3	ENRT022203	ENRT022203	ENRT022203

### D挫

- 材料为专用镍钛合金，具有良好的抗折性和弹性。
- 用于根管再治疗时去除牙胶尖及充填物。
- 推荐旋转速度为150- 300转 / 分钟，扭矩2.SN.cm
- 3支装：分单色装和混色装。

### Gates drills

- Made of high quality medical stainless steel
- With high quality cutting efficiency
- Recommended rotary speed 800-1200r/min
- 6pcs per pack, available for single or assorted sizes.



### G钻

- 不锈钢材质
- 顶端有安全钝头
- 柄部环形标记
- 推荐转速800-1200转 / 分钟
- 6支装·分单号装和混号装

Size	28mm	32mm
1#	ESGZ028001	ESGZ032001
2#	ESGZ028002	ESGZ032002
3#	ESGZ028003	ESGZ032003
4#	ESGZ028004	ESGZ032004
5#	ESGZ028005	ESGZ032005
6#	ESGZ028006	ESGZ032006
1-6#	ESGZ028203	ESGZ032203

### Pesso reamers

- Made of high quality medical stainless steel
- With high quality cutting efficiency
- Recommended rotary speed 800-1200r/min
- 6pcs per pack, available for single or assorted sizes.



### p钻

- 不锈钢材质
- 顶端有安全钝头
- 柄部环形标记
- 推荐转速800-1200转 / 分钟
- 6支装·分单号装和混号装

Size	28mm	32mm
1#	ESPZ028001	ESPZ032001
2#	ESPZ028002	ESPZ032002
3#	ESPZ028003	ESPZ032003
4#	ESPZ028004	ESPZ032004
5#	ESPZ028005	ESPZ032005
6#	ESPZ028006	ESPZ032006
1-6#	ESPZ028203	ESPZ032203

### Paste carriers

- Made of high quality medical stainless steel
- For filling sealer or cement to root canal
- High temperature sterilization is available
- 4pcs per pack, available for single or assorted sizes

### 输送针

- 材料为医用不锈钢
- 用于输送药物糊剂填充根管
- 允许高温消毒
- 4支装，分单色和混色包装



Size	21mm	25mm	29mm
25#	EPC0221025	EPC0225025	EPC0229025
30#	EPC0221030	EPC0225030	EPC0229030
35#	EPC0221035	EPC0225035	EPC0229035
40#	EPC0221040	EPC0225040	EPC0229040
25-40#	EPC0221203	EPC0225203	EPC0229203

### Barbed Broaches

- Made of high quality medical stainless steel
- Advance technology, good flexibility and not easy broken
- For removing dental pulp tissue
- 10pcs per pack, available for single or assorted sizes.

### 拔髓针

- 材料为医用不锈钢
- 精密加工工艺，产品性能卓越，抗折断
- 用于除去牙髓组织
- 10支装，分单色和混色包装



Size	21mm	25mm
00#	HSBB021000	HSBB025000
01#	HSBB021001	HSBB025001
02#	HSBB021002	HSBB025002
03#	HSBB021003	HSBB025003
04#	HSBB021004	HSBB025004
05#	HSBB021005	HSBB025005
06#	HSBB021006	HSBB025006
0-6#	HSBB021203	HSBB025203

### C+ Files

- The 3mm pointed end with high hardness, it is more hardness than normal files. It will be easy for clearing the calcified root canal.
- The file is very flexible, it could use smoothly along the wall of root canal.
- Suggest one time use
- 6pcs per pack, available for single or assorted sizes.

### C+ 挫

- C+挫的 尖部3mm 部位硬度较高，易于疏通钙化根管。
- 挫身尾部韧性较好，能沿着根管壁方向顺畅下行。
- 建议一次性使用
- 6支装，分单色装和混色装



Size	21mm	25mm	31mm
06#	HSC021006	HSC025006	HSC031006
08#	HSC021008	HSC025008	HSC031008
10#	HSC021010	HSC025010	HSC031010
15#	HSC021015	HSC025015	HSC031015
20#	HSC021020	HSC025020	HSC031020
06-10#	HSC021203	HSC025203	HSC031203

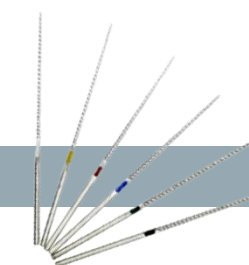

### U files

- Niti or stainless steel
- Used with ultrasonic instruments, wash the root canal
- 6pcs per pack, available for single or assorted sizes

### 超声波挫

- 镶钛或不锈钢材料
- 与超声波仪器一起使用，荡洗根管
- 6支装：分单色和混色包装

Size	33mm	Size	33mm
15#	SU02033015	15#	NU02033015
20#	SU02033020	20#	NU02033020
25#	SU02033025	25#	NU02033025
30#	SU02033030	30#	NU02033030
35#	SU02033035	35#	NU02033035
40#	SU02033040	40#	NU02033040
15-40#	SU02033203	15-40#	NU02033203

### Diamond bur

- Made of natural diamond powder, with high hardness to guarantee the sharpness of burs
- The diamond powder is fixed under high technology which to guarantee the durability
- The shanks are made of top-grade stainless steel which are hard and tensile and don't break or bend easily

### 金刚砂

- 材料为天然金刚砂粉，具有高硬度保证切削力
- 运用高科技固定砂粉，不掉砂，产品使用寿命长
- 车针由顶级不锈钢制作，硬度高，抗弯曲



**Gutta percha points**

- X-rays can be blocked for radiography
- Taper : 0.02, 0.04, 0.06
- A product that matches the variety (F1, F2, F3)
- Sizes: from 15# to 80#, assorted 15-40#

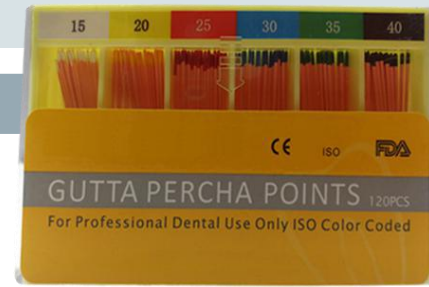

Size	0.02taper	0.04taper	0.06taper
015	0215#	0415 #	0615#
020	02 20#	04 20#	06 20#
025	02 25#	04 25#	06 25#
030	02 30#	04 30#	06 30#
035	02 35#	04 35#	06 35#
040	02 40#	04 40#	06 40#
015-40	02 15-40#	0415 -40#	0615-40#
045-80	02 45-80#		

**牙胶尖**

- 拥有良好的X射线阻射
- 锥度: 0.02,0.04, 0.06
- 与变锥铤 ( F1, F2, F3) 匹配的产品
- 型号: 从 15 #到80#, 混装 15-40#

**Absorbent paper points**

- Highly absorbent
- Color coded
- Taper : 0.02, 0.04, 0.06
- A product that matches the variety (F1, F2, F3)
- Sizes : from 15# to80#, assorted 15-40#



Size	0.02taper	0.04taper	0.06taper
015	0215#	0415 #	0615#
020	02 20#	04 20#	06 20#
025	02 25#	04 25#	06 25#
030	02 30#	04 30#	06 30#
035	02 35#	04 35#	06 35#
040	02 40#	04 40#	06 40#
015-40	02 15-40#	0415 -40#	0615-40#
045-80	02 45-80#		

**吸潮纸尖**

- 拥有良好的吸水性
- 纸尖顶端有颜色可避免各型号混淆
- 锥度: 0.02,0.04, 0.06
- 与变锥铤 ( F1, F2, F3) 匹配的产品
- 型号: 从 15 #到80#, 混装 15-40#

**Endo ruler**

- Measuring ruler and measuring orifice on one ruler, easy to use
- Measurement ruler lines clear and precise
- autoclave sterilization available



**测量尺**

测量尺和定径孔集为一体, 方便使用  
测量标尺刻度清晰精准  
可高温消毒

**Endo block**

- Setting the working length of root canal files
- Medical grade plastic, autoclave sterilization available



**测量台**

- 根管挫胶垫定位, 标记根管挫工作长度
- 医用级塑料制作, 可高温消毒

**Dental screw post**

- Made of Stainless steel, Golden plated or titanium
- 120pcs/set, 240pcs/set, refill 12pcs/box



**根管桩**

- 分为不锈钢, 镀金, 纯钛三种材料
- 有120支装, 240支装, 12支补充装

**Screw Post**

Diameter	Length	No.	Stainless Steel	Golden Plated	Titanium
Φ 1.05	8 mm	S1			
	9.5 mm	M1			
	12 mm	L1			
Φ 1.20	8 mm	S2			
	9.5 mm	M2			
	12 mm	L2			
Φ 1.35	8 mm	S3			
	9.5 mm	M3			
	12 mm	L3			
Φ 1.50	8 mm	S4			
	9.5 mm	M4			
	12 mm	L4			
	14 mm	XL4			
Φ 1.65	8 mm	S5			
	9.5 mm	M5			
	12 mm	L5			
Φ 1.80	8 mm	S6			
	9.5 mm	M6			
	12 mm	L6			
	14 mm	XL6			

- 120pcs/set, 240 pcs/set



- refill 12pcs/box

**Drills for screw post**

- Made of high quality medical stainless steel
- Ring mark on handle
- The tip has a safe blunt tip
- Recommended rotary speed is 800-1200r/min
- 6pcs per pack, available for single or assorted sizes

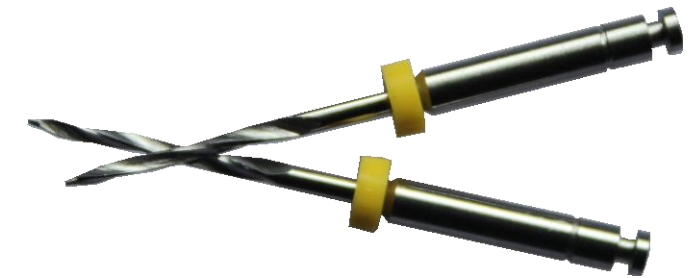

**根管桩钻头**

- 不锈钢材质
- 柄部有环形标记
- 尖端有安全钝头
- 推荐转速800-1200转 / 分
- 6支装, 分单号和混号包装

Size	32mm
01#	ESS032001
02#	ESS032002
03#	ESS032003
04#	ESS032004
05#	ESS032005
06#	ESS032006
1-6#	ESS032203



Shape	Sizes	
Round	0012	upper/lower
	0014	upper/lower
	0016	upper/lower
	0018	upper/lower
	0020	upper/lower
Rectangular	0 016*0016	upper/lower
	0.016*0.022	upper/lower
	0.017*0.022	upper/lower
	0 017*0025	upper/lower
	0 018*0022	upper/lower
	0 018*0025	upper/lower
	0 019*0025	upper/lower
0 021*0025	upper/lower	

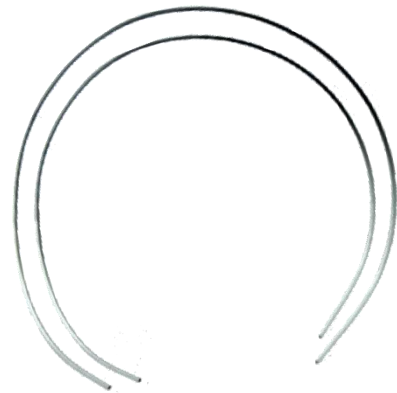

Shape	Sizes	
Closed spring	0.010	
	0.012	
Open spring	0.010	
	0.012	



Shape	Sizes	
Round	0012	upper/lower
	0014	upper/lower
	0016	upper/lower
	0.018	upper/lower
	0020	upper/lower
Rectangular	0 016*0016	upper/lower
	0 016*0022	upper/lower
	0 017*0022	upper/lower
	0 017*0025	upper/lower
	0 018*0022	upper/lower
	0 018*0025	upper/lower
	0 019*0025	upper/lower
0021*0025	upper/lower	

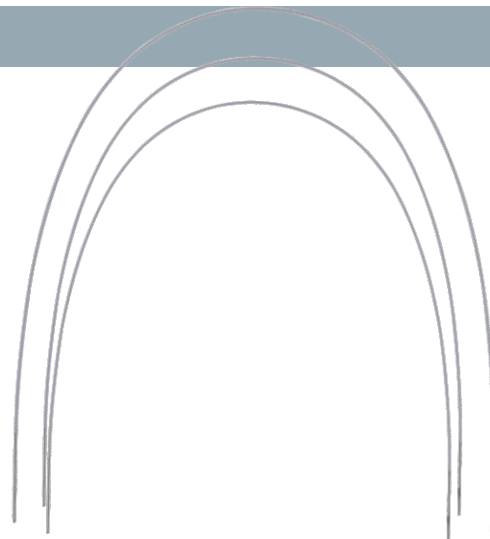

### Drills for fiber post

- Made of high quality medical stainless steel
- Ring mark on handle
- The tip has a safe blunt tip
- Recommended rotary speed is 800-1200r/min
- 4pcs per pack, available for single or assorted sizes



### 纤维桩钻头

- 不锈钢材质
- 柄部有环形标记
- 尖端有安全钝头
- 推荐转速800-1200转 / 分
- 4支装，分单号和混号包装

Size	32mm
01#	ESZ032001
02#	ESZ032002
03#	ESZ032003
04#	ESZ032004
1-4#	ESZ032203

